

AQUAFINE

AVANT™ Series

State-of-the-art TOC Destruction System for Ultra-Pure Water (UPW) Applications



Distribuidor España
Tels.: +34 932 018 466 / 932 010 867
info@aquabona.biz / www.aquabona.biz





Meet Stringent TOC Destruction with a Small Footprint, Predictive Diagnostics and Significant OPEX Savings.

Avant is a highly advanced product line that provides TOC reduction performance in up to a three times smaller footprint than prior series. The Avant Series utilizes less energy and provides full flexibility for skid-mounted designs, with the ability to mount eight reactors in up to 75% smaller footprint compared to our previous offering.

With the Predictive Maintenance capabilities, Avant ensures the system operates optimally and monitors the lamp characteristics of individual lamps and alerts the Plant Operators to change a lamp before failure, reducing unplanned maintenance costs and downtime.

Avant incorporates innovations, and best in-class components, to reduce the total cost of ownership and drastically simplify operation and maintenance. It is the ideal solution for UPW plants in need of revolutionary UV technology.

Avant is our advanced UV system designed with decades of experience in TOC applications. There are two models offered: Avant and Avant High Performance (HP). Avant High Performance utilizes a unique lamp and sleeve combination that helps to significantly improve the units overall performance.

Key Benefits

Aquafine Avant

Improved Performance. Up to three times more flow for a given TOC Destruction compared to the prior series systems to satisfy the stringent low level TOC requirement for high flow UPW plants.

Compact Footprint. Use of high performance lamp and sleeve material reduces the footprint by up to 75%, and in turn lowering the construction and installation costs, providing unparalleled cost and maintenance advantages.

User-friendly Operator Interface. Intuitive interface enables at-a-glance system status checks, making life easier for engineers and plant operators.

Predictive Diagnostics. The advanced control features provide predictive maintenance alerts when the lamp approaches end of lamp life and show unusual power consumption or operating pattern to help in preventing downtime.

Reduced OPEX. Fewer UV units to maintain and significantly less lamps result in extremely low power consumption.

Delivering Water Confidence and Comprehensive Warranty. Aquafine UV Systems include a Lifetime Performance Guarantee and industry-leading warranties for systems and parts.

Global Support. Local Service. Our comprehensive network of local certified service providers offers fast response for service and spare parts for the Microelectronics industry.

For UPW Applications with state-of-the-art system design and advanced controls

Programmable Logic Controller (PLC)

The controller continuously monitors and controls UV system functions including safety conditions. Critical and non-critical alarms are generated based on these safety conditions. Critical alarms shutdown the UV lamps and drivers.

An intuitive 7" touch-screen HMI allows the operator to configure various settings with ease. The easy-to-navigate HMI screen displays the status of individual lamps including detailed diagnostics.

Configurable Inlet/Outlet

Water can flow in either direction allowing the units to adapt to customer's piping requirements.

UV Intensity Sensor *

UV sensors measure the intensity of UV light within the reactor while the system is in operation: these sensors are critical in monitoring the performance of the UV Reactor and are supplied.

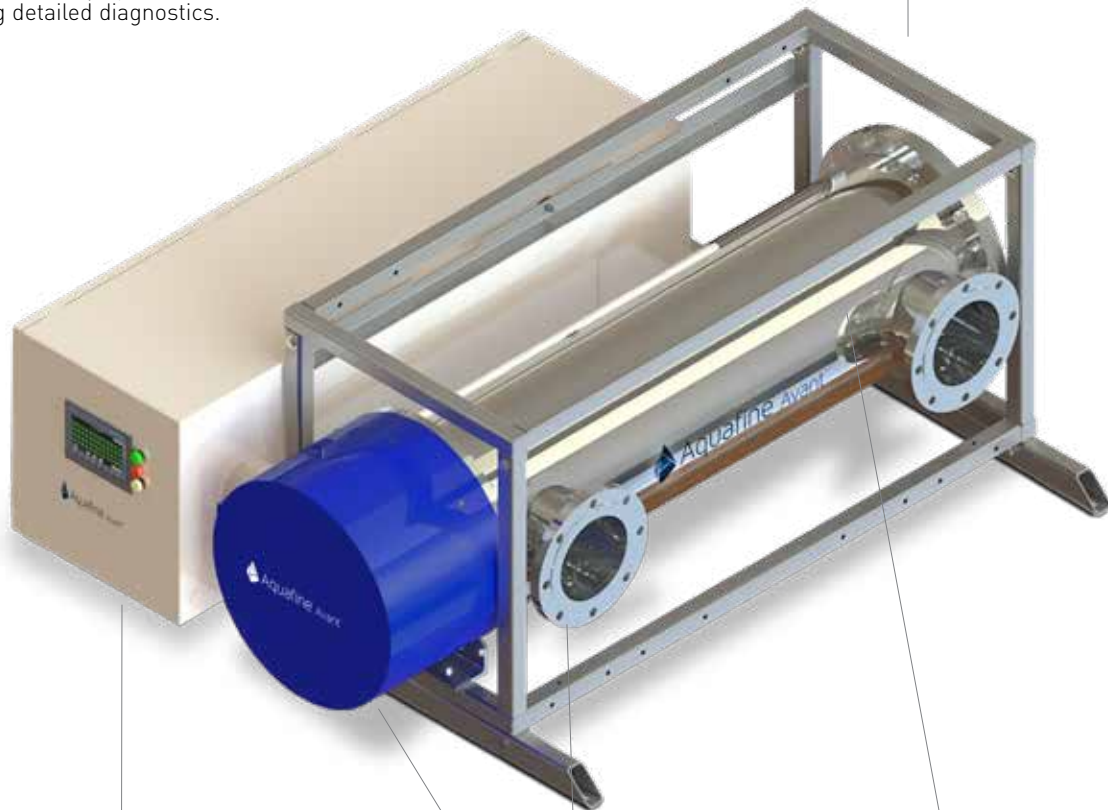

Panel Enclosure

The Painted Carbon Steel is a UL Type 12 panel. The panels are available in skid-mounted or stand-alone variations.

End Cap

The end cap protects and isolates connections for components such as lamps and sleeves. Power is automatically disconnected if end cap is removed thereby ensuring a safe working environment for operators.

UV Chamber

Electropolished 316L stainless steel chamber available in multiple configurations for a wide range of flow rates. Optional flange orientations allow chambers to fit into existing piping galleries or tight spaces.

Lamps

High Efficiency, High Output lamps are energy efficient, to provide superior system performance, and save operating costs due to reduced electric consumption. Single ended lamps are located within protective quartz sleeves with easy access from the service entrance.

* Part of Upgrade Package

High Performance, Compact Footprint

Save space, and treat more flow

Avant-High Performance is an advanced TOC destruction product line that provides improved performance up to three times than our previous series and most conventional UV TOC products.

The reduction in UV units not only helps to save in upfront capital investment, but also significantly reduces the installation expenses.

Avant's modular skid configuration allows multiple units to be stacked, taking advantage of Aquafine's technology in a compact and easily expandable footprint.



Available configurations range with options for different manifolds and valves

Avant High-Performance (HP) model uses **special grade quartz sleeve** and lamps that allows to significantly **reduce** the number of UV units by **up to 75%**.

8 X SCD-H

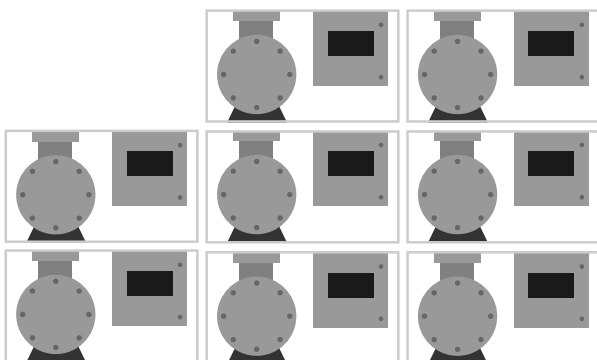

3 X Avant HP

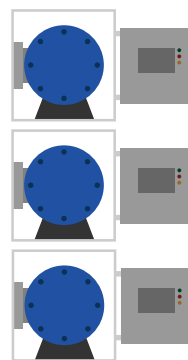

**62.5%
Footprint
Savings!**

State-of-the-Art Controls and Predictive Maintenance

User friendly operator interface with touch screen for easy operation and monitoring

Predictive Maintenance Tool

Predictive maintenance tool is able to monitor the health of individual lamps and predict if a lamp is about to fail.

By proactively changing lamps before failure, the general maintenance cost of the equipment and downtime are reduced.



Smart Driver Technology

The Avant series has a robust safety mechanism that comes with smart driver technology.

The smart driver recognizes when the lamps are not striking an arc after a determined number of trials. In this scenario, the Avant will no longer try to turn on the lamps and trigger an alarm. This feature prevents the driver from being damaged by trying to turn on a lamp that is no longer operational thus protecting the equipment and reducing maintenance costs.



Remote System Monitoring

In addition to the Predictive Maintenance Tool and Smart Driver Technology, the Avant series offers a comprehensive view of lamp and driver health for operational safety and evaluating condition of the system.

Communication protocols included in the base models enable users to continuously monitor all available system information from a remote location, which reduces operational expenses and allows for immediate action if an issue may arise.

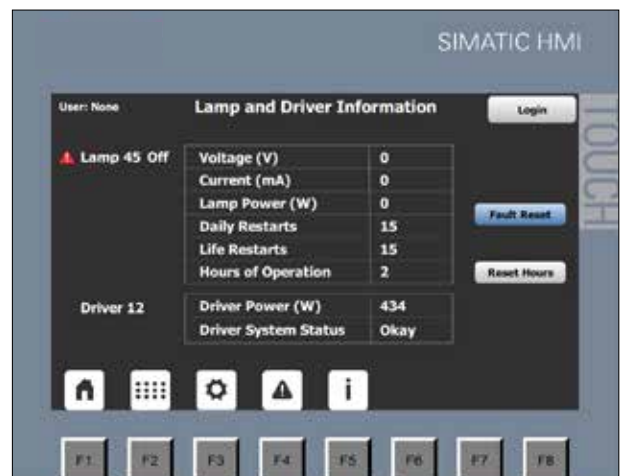

Lower Operating and Maintenance Expense

Significant reduction in number of lamps to replace and maintain on annual basis

We understand that increasing flow requirements creates the need for larger UPW plants, which increases the overall operating expenses. The extremely efficient lamp technology significantly cuts down on the number of lamps needed to cover the needs of high flow UPW plants. This allows the plant operators to significantly save on energy expenditures, lamp replacement costs, and maintenance expenses.

In the comparison scenario below, our new product line, Avant only required 37.5% of lamps or power consumption compared to the old product line (SCD-H). Avant met the same performance level to reduce TOC levels below 2 ppb with significantly lower power consumption.

	SCD-H	Avant
Unit Quantity	8	3
Annual Power Consumption	531,050 KW	209,121 KW

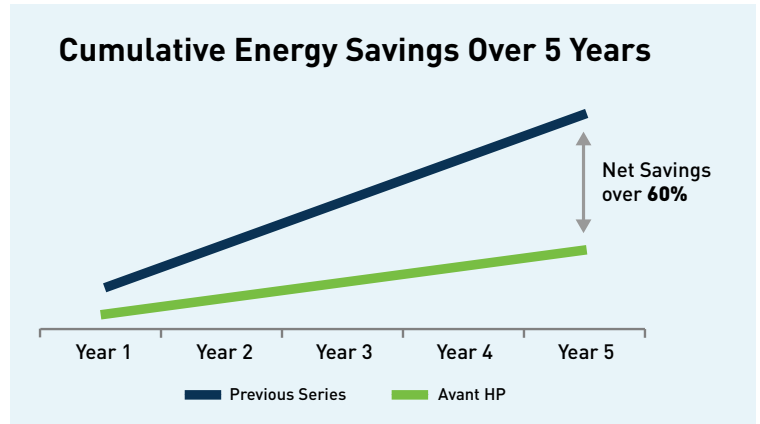



High Energy Savings

Lower Lamp Replacement Costs

Easy Maintenance

Proven Core Components

System Specifications*

System Characteristics	Avant / Avant High Performance (HP)
Avant (4 Models)	50-300gpm (11-68 m ³ /hr)
Avant-High Performance (4 Models)	100-900gpm (22-204 m ³ /hr)
Lamp Type	Low Pressure High Output
Lamp Driver	Electronic (variable power)
Chamber Material	316L Stainless Steel
Flange Size	4 - 8 inch (10.16 cm - 20.32 cm)
Pressure Rating	Up to 150 psi (PN10)
Panel Rating, Material	MODULAR: ULType 1 (IP51) Painted Carbon Steel STANDALONE: ULType 12 (IP52) Painted Carbon Steel STANDALONE: ULType 4X (IP55 with fan)
Certifications	  

*Please contact Aquafine Applications Team for additional details.

Aquafine Performance Guarantee and Regional Support

Aquafine provides a Lifetime Performance Guarantee for its UV products. A Lifetime Performance Guarantee means that the UV system will achieve the targets for which it was designed and sized on the original sales order of the equipment which considers operational parameters such as UVT of the fluid, maximum flow rate, operating pressure, fluid temperature, among others.

The Lifetime Performance Guarantee will only be applicable with the use of genuine OEM replacement parts. This guarantee is valid for the life of the equipment and it is available for both new and existing equipment when applicable conditions are met.

Customer support is available from our Authorized Distributor Network and from our 24/7 Technical Service Group.

For questions regarding your application needs, please contact your local Authorized Distributor or Aquafine for more information. Please reach out to us at www.aquafineuv.com/contact.



Distribuidor España
Tel: +34 932 018 466 / 932 010 867
info@aquabona.biz / www.aquabona.biz

Aquafine is an ISO 9001 certified company. Aquafine equipment performance is guaranteed with the use of genuine OEM replacement parts.

North America & International | 29010 Ave. Paine, Valencia, CA 91355 | P +1 661 257 4770 F +1 661 257 2489 | www.aquafineuv.com
Europe | Ramskamp 77-85 D-25337 Elmshorn, Germany | P. +49 4121 57806 13 F. +49 4121 57806 30 | www.aquafineuv.com

© Aquafine Corporation 2019. All rights reserved. This document is not to be copied, electronically stored or reproduced without written permission from Aquafine Corporation. All specifications are subject to change without notice.

TSG 317_RevA-19